

FORONE HUIYI

**SHAPES PANELS**

## FACTORY INTRODUCTION

Foshan Huiyi New Material Technology Co., Ltd., with its factory located in Foshan, Guangdong, was founded in 2018. We are committed to creating a brand featured with "quickness" in China's decoration industry. Our BPC boards and Shapes Panels have the advantages of diverse decorative boards and better results.

Currently, we have a workshop of 20,000m<sup>2</sup> with an annual output of 3,000,000m<sup>2</sup>. We have new advanced equipment, including 16 extrusion lines, 13 wrapping machines and one flat laminating machine with a daily output of 30,000m<sup>2</sup>. Our raw materials are made by mixing bamboo powder, resin powder, calcium powder and tubing through blender mixers.

We have a professional R&D team, and a number of products have been awarded the environmental-friendly aldehyde-free certificate, flame retardant certificate, etc. Our factory is the vice president unit of decoration supply chain in Foshan and 3A-level quality credit enterprise unit. We have been awarded "The Most Favored Building Material Brand by Designer", and have obtained the certificates of ISO9001 and SGS.CE.

The "FORONE" series provides plentiful of Shapes Panels and quick-install wall board for export. We have more than 30,000m<sup>2</sup> base core inventory and 500,000m<sup>2</sup> decorative film inventory. Lead time for regular size is 7 days and customize size product is 15 days

Better products, Better quality, Better service

Application Scenario 应用场景



CORPORATE IMAGE WALL 企业形象墙

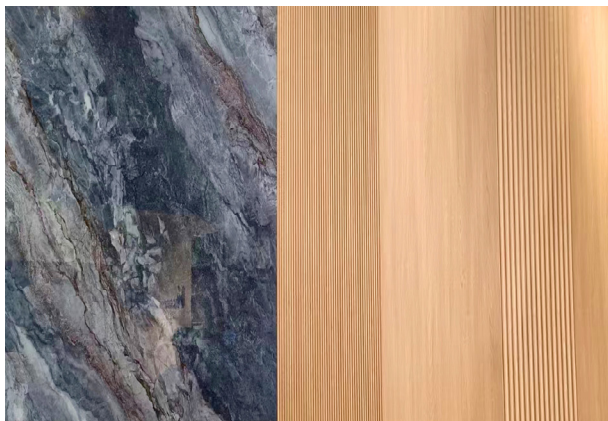

COMMERCIAL SPACE 商业空间



FURNITURE 应用家具上

PRODUCT DESCRIPTION 产品说明

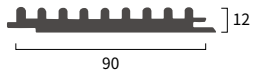

MODEL 型号: 90WYCC 微圆长城

FRONT SIZE AFTER INSTALLATION

安装后尺寸: 90mm(W)\*3000mm(H)

Panels/box 支 / 箱: 20

KG/m 千克 / 米: 1

Weight/box 重量 / 箱: 60.5

Cubic meter/box 立方 / 箱: 0.1

Container Capacity: About 4320 Panels (20'GP/DV) 约 4320 支 (20 尺柜)

About 8640 Panels (40'GP/DV) 约 8640 支 (40 尺柜)

About 10800 Panels (40'HC/HQ) 约 10800 支 (40 尺高柜)

SELL WELL COLOR SELECTION 畅销款颜色选择

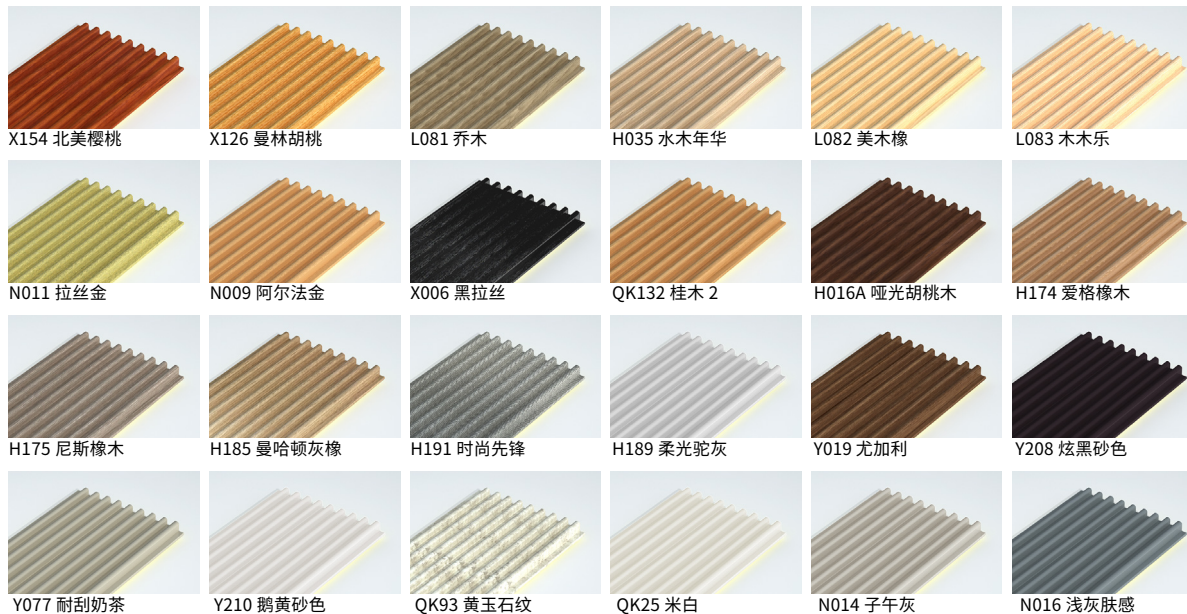

COLOR SELECTION

更多颜色定制请看色卡

Application Scenario 应用场景

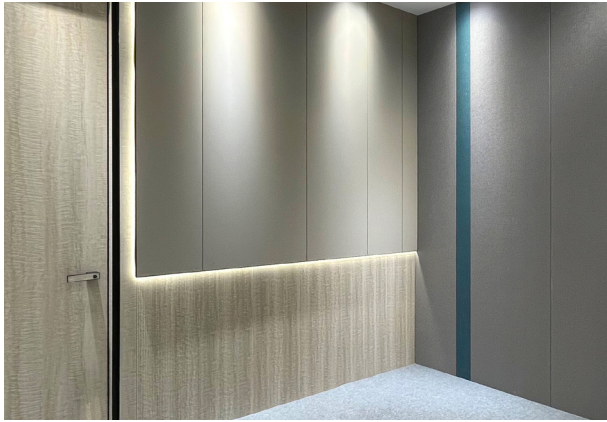

HOME SPACE 居家空间



DINING ROOM 餐厅



HOTEL BACKGROUND WALL 酒店背景墙

PRODUCT DESCRIPTION 产品说明

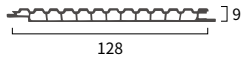
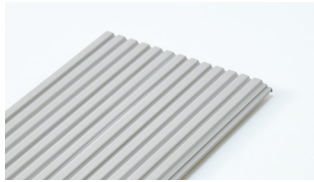

MODEL 型号: 128CHB 长虹板

FRONT SIZE AFTER INSTALLATION

安装后尺寸: 128mm(W)\*3000mm(H)

Panels/box 支 / 箱: 24

KG/m 千克 / 米: 0.65

Weight/box 重量 / 箱: 48

Cubic meter/box 立方 / 箱: 0.15

Container Capacity: About 4320 Panels (20'GP/DV) 约 4320 支 (20 尺柜)

About 8640 Panels (40'GP/DV) 约 8640 支 (40 尺柜)

About 10800 Panels (40'HC/HQ) 约 10800 支 (40 尺高柜)

SELL WELL COLOR SELECTION 畅销款颜色选择

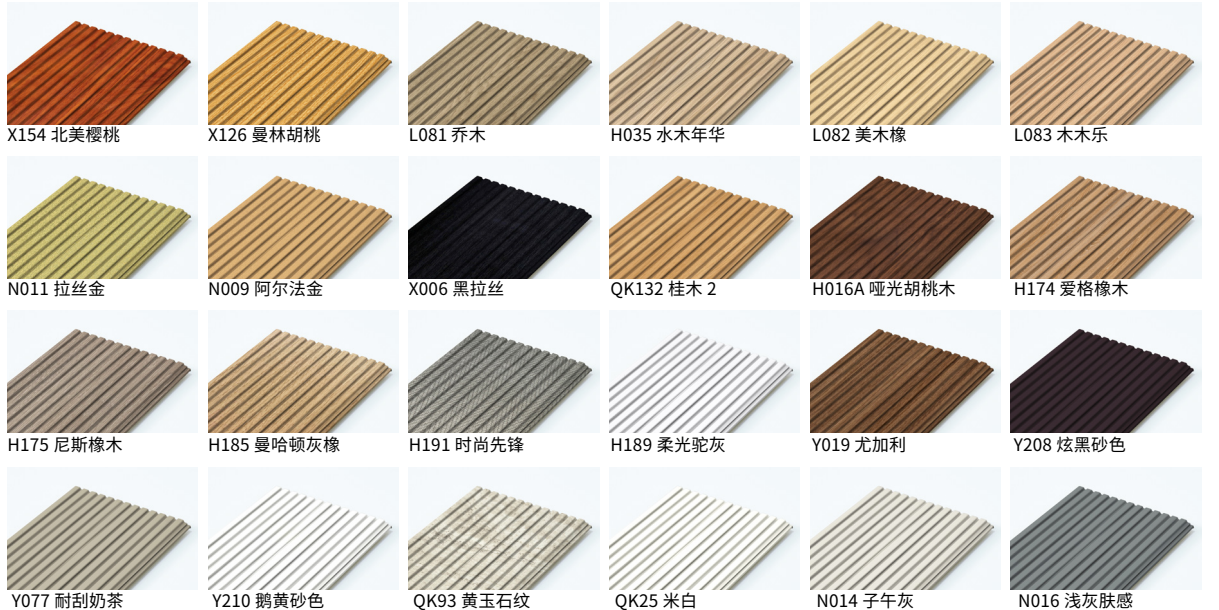

COLOR SELECTION

更多颜色定制请看色卡

PRODUCT DESCRIPTION 产品说明

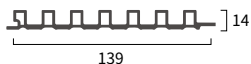

MODEL 型号: 139XGS 小格栅

FRONT SIZE AFTER INSTALLATION

安装后尺寸: 139mm(W)\*3000mm(H)

Panels/box 支 / 箱: 18

KG/m 千克 / 米: 0.9

Weight/box 重量 / 箱: 60.5

Cubic meter/box 立方 / 箱: 0.1

Container Capacity: About 4320 Panels (20'GP/DV) 约 4320 支 (20 尺柜)

About 8640 Panels (40'GP/DV) 约 8640 支 (40 尺柜)

About 10800 Panels (40'HC/HQ) 约 10800 支 (40 尺高柜)

SELL WELL COLOR SELECTION 畅销款颜色选择

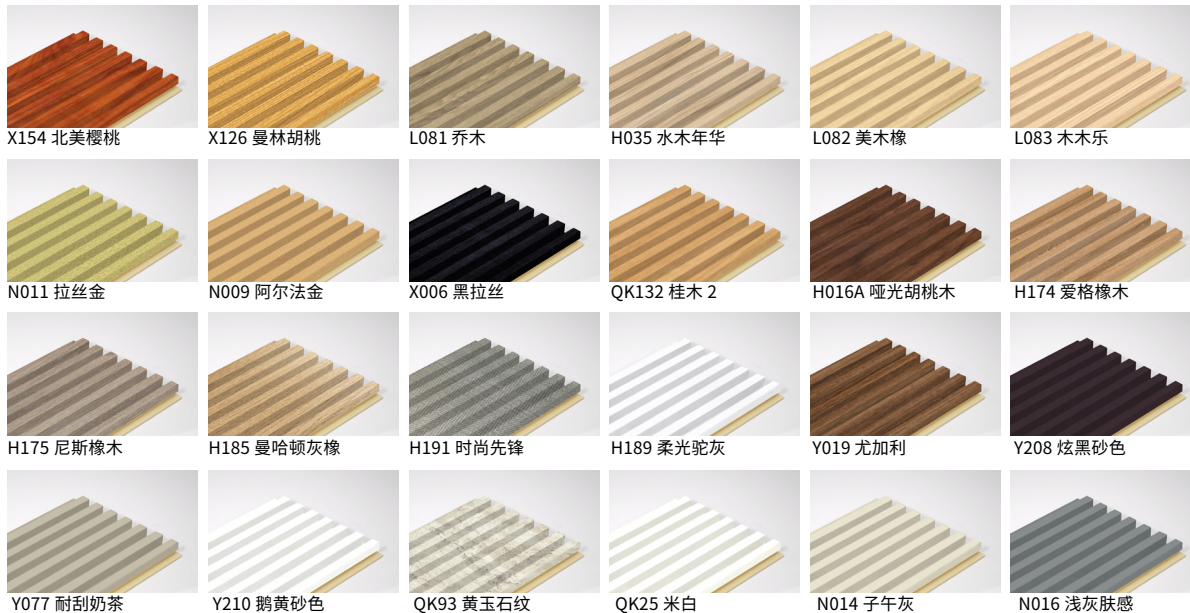

COLOR SELECTION

更多颜色定制请看色卡



RECEPTION AND NEGOTIATION AREA 接待洽谈区

Application Scenario 应用场景



APARTMENT LIVING ROOM 公寓客厅



SHOW ROOM 应用场景

Application Scenario 应用场景



OFFICE 办公室

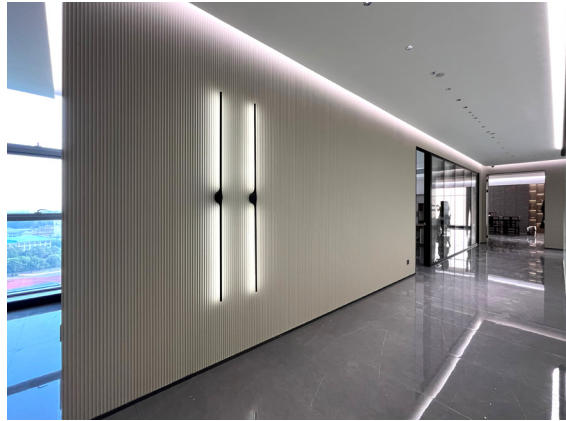

OFFICE 办公室



EXHIBITION HALL 展示厅

PRODUCT DESCRIPTION 产品说明

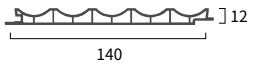
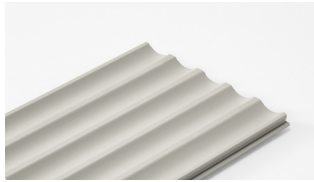

MODEL 型号: 140BLB 波浪板

FRONT SIZE AFTER INSTALLATION

安装后尺寸: 140mm(W)\*3000mm(H)

Panels/box 支 / 箱: 20

KG/m 千克 / 米: 0.9

Weight/box 重量 / 箱: 55

Cubic meter/box 立方 / 箱: 0.1

Container Capacity: About 4320 Panels (20'GP/DV) 约 4320 支 (20 尺柜)

About 8640 Panels (40'GP/DV) 约 8640 支 (40 尺柜)

About 10800 Panels (40'HC/HQ) 约 10800 支 (40 尺高柜)

SELL WELL COLOR SELECTION 畅销款颜色选择

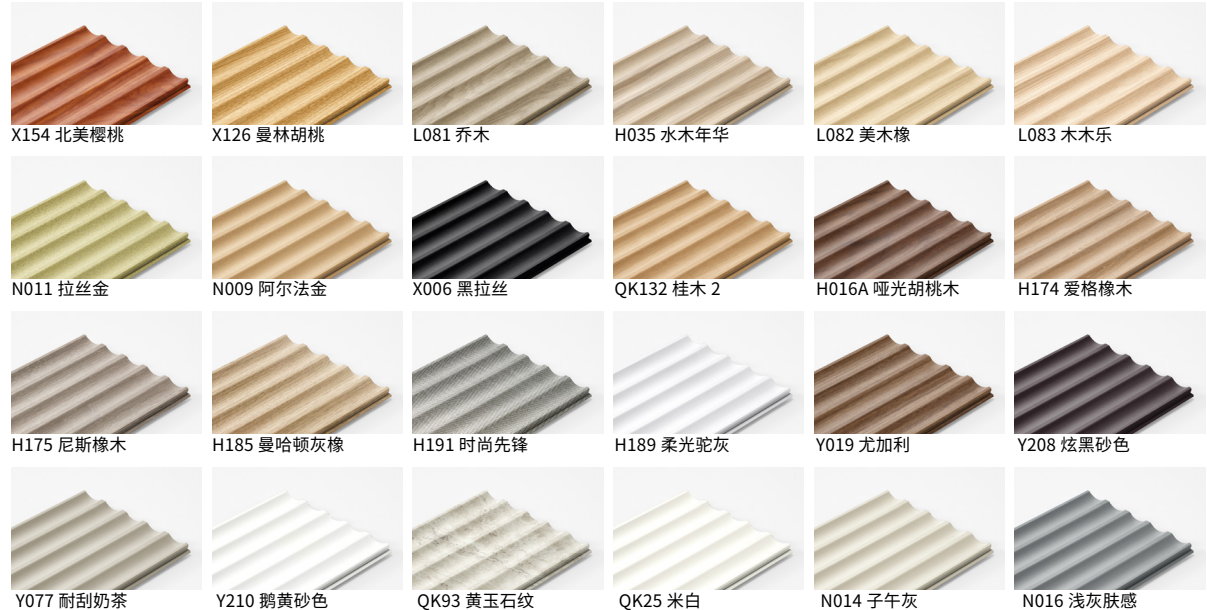

COLOR SELECTION

更多颜色定制请看色卡

PRODUCT DESCRIPTION 产品说明

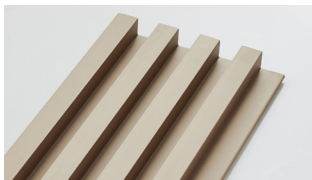

MODEL 型号: 160GS 格栅

FRONT SIZE AFTER INSTALLATION

安装后尺寸: 160mm(W)\*3000mm(H)

Panels/box 支 / 箱: 16

KG/m 千克 / 米: 1.1

Weight/box 重量 / 箱: 50.5

Cubic meter/box 立方 / 箱: 0.12

Container Capacity: About 4320 Panels (20'GP/DV) 约 4320 支 (20 尺柜)

About 8640 Panels (40'GP/DV) 约 8640 支 (40 尺柜)

About 10800 Panels (40'HC/HQ) 约 10800 支 (40 尺高柜)

SELL WELL COLOR SELECTION 畅销款颜色选择

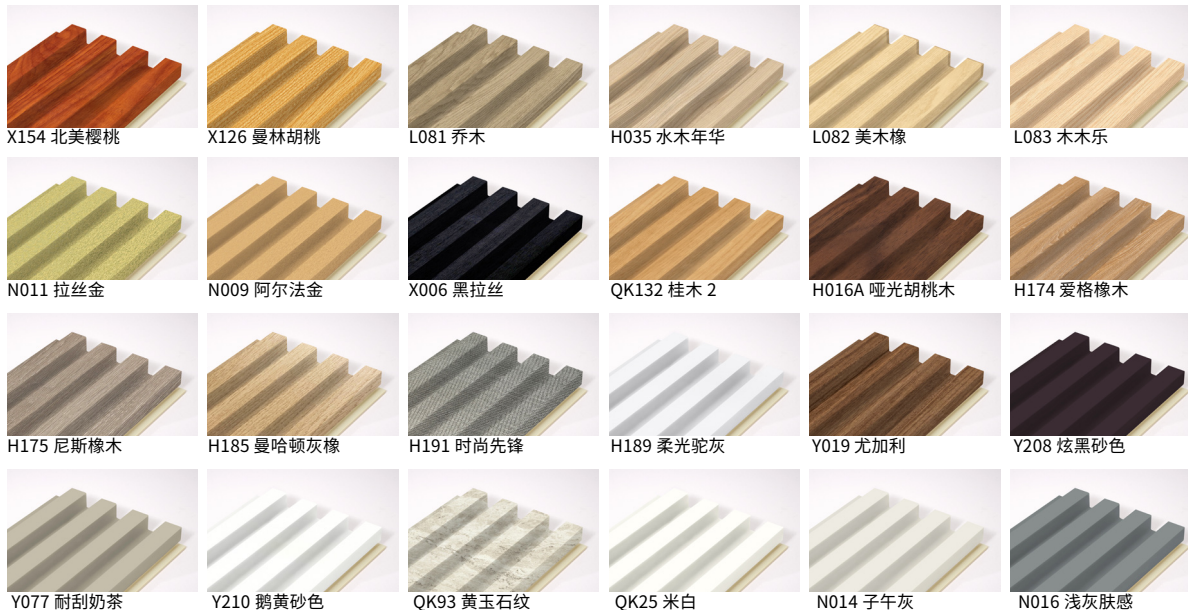

COLOR SELECTION

更多颜色定制请看色卡

Application Scenario 应用场景



THE HOTEL LOBBY 酒店大堂

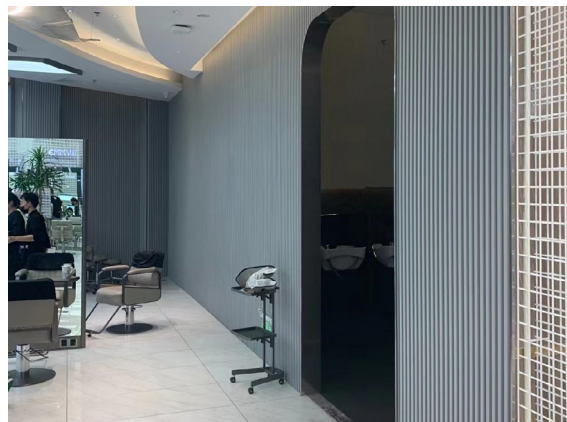

BARBER SHOP 理发店



DINING ROOM 餐厅

Application Scenario 应用场景



RECEPTIONR 前台



CLUB 会所



HOME SPACE 居家空间

PRODUCT DESCRIPTION 产品说明

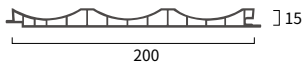
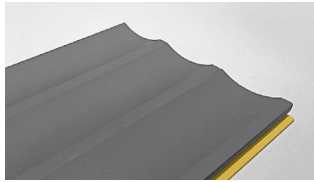

MODEL 型号: 200YLB 月亮板

FRONT SIZE AFTER INSTALLATION

安装后尺寸: 200mm(W)\*3000mm(H)

Panels/box 支 / 箱: 14

KG/m 千克 / 米: 1.5

Weight/box 重量 / 箱: 65

Cubic meter/box 立方 / 箱: 0.17

Container Capacity: About 4320 Panels (20'GP/DV) 约 4320 支 (20 尺柜)

About 8640 Panels (40'GP/DV) 约 8640 支 (40 尺柜)

About 10800 Panels (40'HC/HQ) 约 10800 支 (40 尺高柜)

SELL WELL COLOR SELECTION 畅销款颜色选择

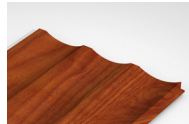

X154 北美樱桃

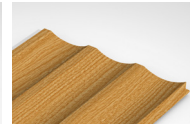

X126 曼林胡桃

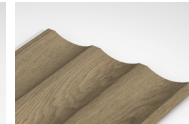

L081 乔木

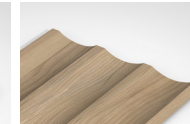

H035 水木年华

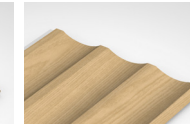

L082 美木橡

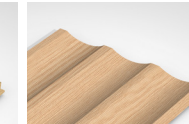

L083 木木乐

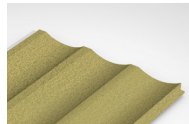

N011 拉丝金

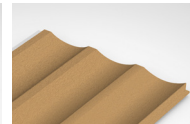

N009 阿尔法金

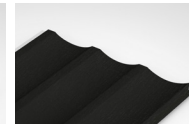

X006 黑拉丝

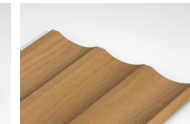

QK132 桂木 2



H016A 哑光胡桃木



H174 爱格橡木

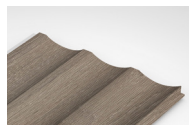

H175 尼斯橡木



H185 曼哈顿灰橡

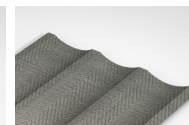

H191 时尚先锋

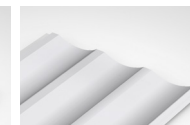

H189 柔光驼灰

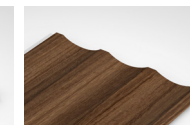

Y019 尤加利

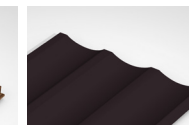

Y208 炫黑砂色

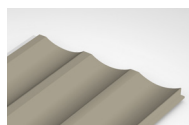

Y077 耐刮奶茶

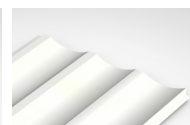

Y210 鹅黄砂色

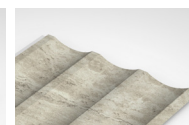

QK93 黄玉石纹

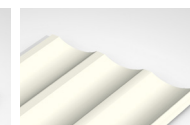

QK25 米白

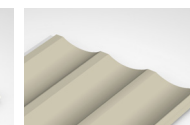

N014 子午灰

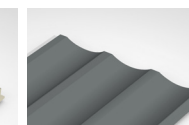

N016 浅灰肤感

COLOR SELECTION

更多颜色定制请看色卡

OTHER MODELS 其他款式选择

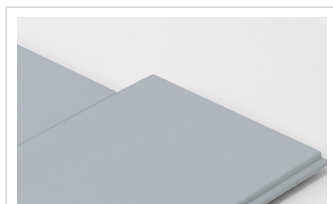

120PB 平板

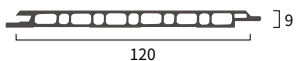

FRONT SIZE AFTER INSTALLATION  
安装后尺寸: 120mm(W)\*3000mm(H)

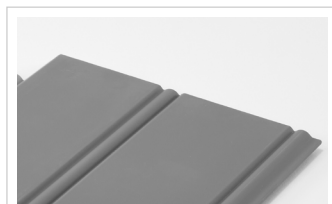

180ZSB 装饰板

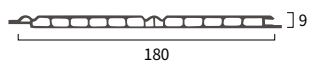

FRONT SIZE AFTER INSTALLATION  
安装后尺寸: 180mm(W)\*3000mm(H)

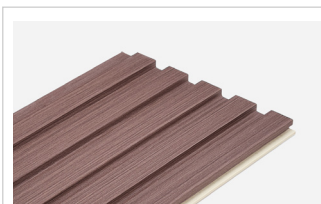

150XCC 小长城

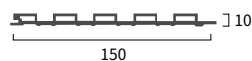

FRONT SIZE AFTER INSTALLATION  
安装后尺寸: 150mm(W)\*3000mm(H)

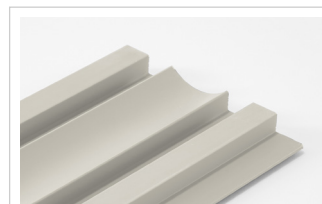

150GYB 格月板



FRONT SIZE AFTER INSTALLATION  
安装后尺寸: 150mm(W)\*3000mm(H)

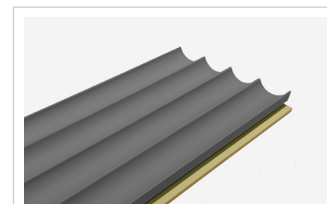

110XSNYB 小四内圆板



FRONT SIZE AFTER INSTALLATION  
安装后尺寸: 110mm(W)\*3000mm(H)

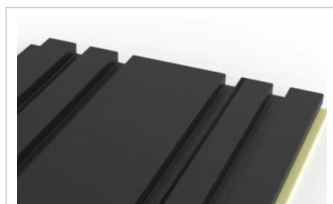

196ZHCCB 组合长城板

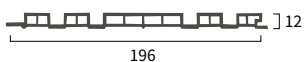

FRONT SIZE AFTER INSTALLATION  
安装后尺寸: 196mm(W)\*3000mm(H)

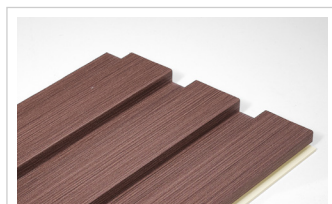

195DCC 大长城

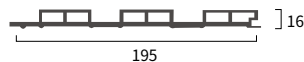

FRONT SIZE AFTER INSTALLATION  
安装后尺寸: 195mm(W)\*3000mm(H)

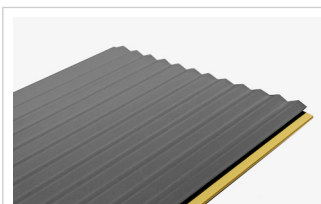

150XSJB 小三角板

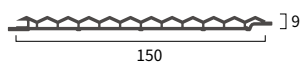

FRONT SIZE AFTER INSTALLATION  
安装后尺寸: 150mm(W)\*3000mm(H)

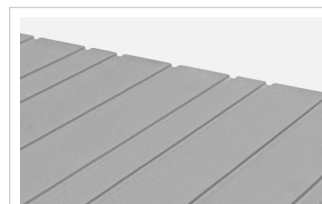

302GTB 格条板

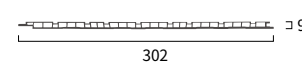

FRONT SIZE AFTER INSTALLATION  
安装后尺寸: 302mm(W)\*3000mm(H)

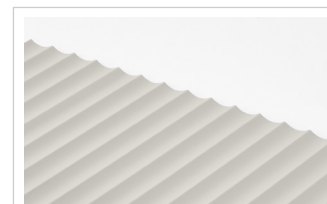

300BLB 波浪板

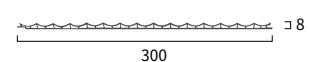

FRONT SIZE AFTER INSTALLATION  
安装后尺寸: 300mm(W)\*3000mm(H)

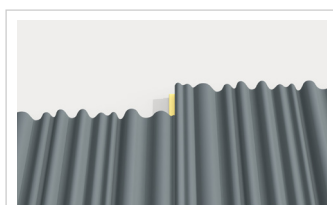

146BGZBLB 不规则波浪板

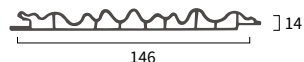

FRONT SIZE AFTER INSTALLATION  
安装后尺寸: 146mm(W)\*3000mm(H)

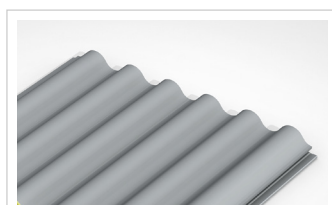

226YHB 圆弧板



FRONT SIZE AFTER INSTALLATION  
安装后尺寸: 226mm(W)\*3000mm(H)



154XBY 小半圆



FRONT SIZE AFTER INSTALLATION  
安装后尺寸: 154mm(W)\*3000mm(H)

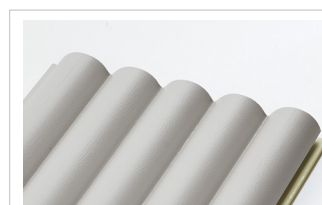

180DBY 大半圆



FRONT SIZE AFTER INSTALLATION  
安装后尺寸: 180mm(W)\*3000mm(H)

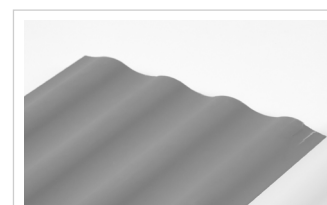

195WYB 外圆板



FRONT SIZE AFTER INSTALLATION  
安装后尺寸: 195mm(W)\*3000mm(H)

OTHER MODELS 其他款式选择

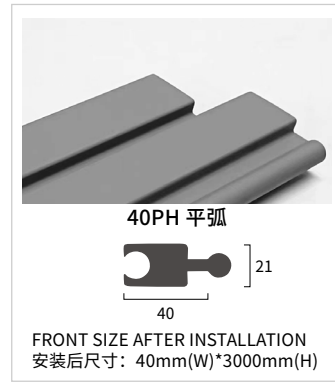
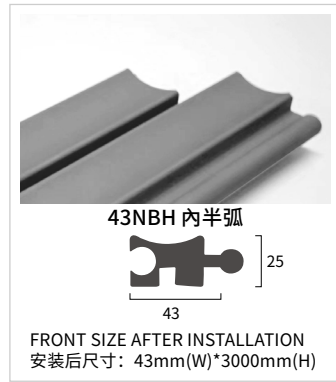
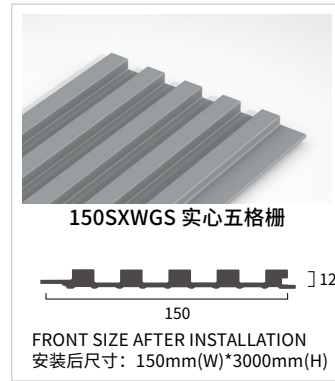
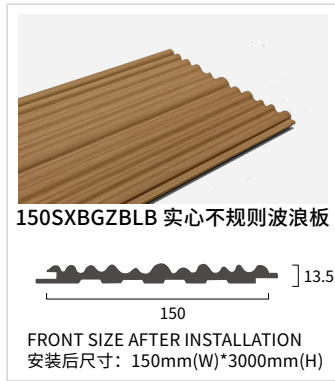

WALL REQUIREMENT 墙面要求



(砖上直接安装)  
On Brick wall



(墙不平木方稍调平)  
With Wall Studs



(龙骨+夹板条)  
Steel Keel+Studs

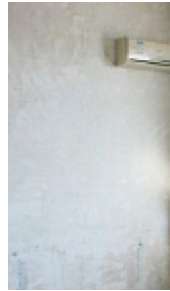

(不需要打底)  
On Paint/Wall Paper

INSTALLATION METHODS 安装方式



水泥墙直接安装  
Directly Install



安装固定链接  
With Metal Clips

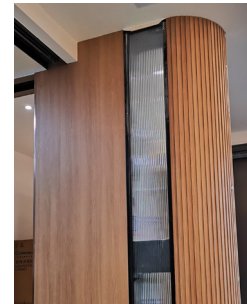

格栅板可弧形  
Bendable&Flexible



SAFE  
ENVIRONMENTALLY FRIENDLY, BEAUTIFUL  
AND EASY TO INSTALL

**B1 LEVEL FIREPROOF**

**WATERPROOF**

SUITABLE FOR HOTEL HOME LIBRARY SCHOOL  
STOREFRONT SUPERMARKET EXHIBITION HALL  
CATERING